

# JEE Main 2018

## SET - D

Actual Question Paper and Answer Key



**Disclaimer:** This content is not created or owned by Info Edge (India) Limited

**Source:** <https://jeemain.nic.in/webinfo/QuestionPapers2018.htm>

# MRF

No.:

This booklet contains 24 printed pages.

**PAPER - 1 : MATHEMATICS, PHYSICS & CHEMISTRY**

Test Booklet Code

Do not open this Test Booklet until you are asked to do so.

Read carefully the Instructions on the Back Cover of this Test Booklet.

**D****Important Instructions :**

1. Immediately fill in the particulars on this page of the Test Booklet with *only Black Ball Point Pen* provided in the examination hall.
2. The Answer Sheet is kept inside this Test Booklet. When you are directed to open the Test Booklet, take out the Answer Sheet and fill in the particulars carefully.
3. The test is of **3 hours** duration.
4. The Test Booklet consists of **90** questions. The maximum marks are **360**.
5. There are *three* parts in the question paper A, B, C consisting of **Mathematics, Physics and Chemistry** having 30 questions in each part of equal weightage. Each question is allotted **4 (four)** marks for correct response.
6. *Candidates will be awarded marks as stated above in instruction No. 5 for correct response of each question.  $\frac{1}{4}$  (one-fourth) marks of the total marks allotted to the question (i.e. 1 mark) will be deducted for indicating incorrect response of each question. No deduction from the total score will be made if no response is indicated for an item in the answer sheet.*
7. There is only one correct response for each question. Filling up more than one response in any question will be treated as wrong response and marks for wrong response will be deducted accordingly as per instruction 6 above.
8. For writing particulars/markings responses on *Side-1* and *Side-2* of the Answer Sheet use *only Black Ball Point Pen* provided in the examination hall.
9. No candidate is allowed to carry any textual material, printed or written, bits of papers, pager, mobile phone, any electronic device, etc. except the Admit Card inside the examination room/hall.
10. Rough work is to be done on the space provided for this purpose in the Test Booklet only. This space is given at the bottom of each page and in **four** pages (Page **20-23**) at the end of the booklet.
11. On completion of the test, the candidate must hand over the Answer Sheet to the Invigilator on duty in the Room/Hall. *However, the candidates are allowed to take away this Test Booklet with them.*
12. The CODE for this Booklet is **D**. Make sure that the CODE printed on *Side-2* of the Answer Sheet is same as that on this Booklet. Also tally the serial number of the Test Booklet and Answer Sheet are the same as that on this booklet. In case of discrepancy, the candidate should immediately report the matter to the Invigilator for replacement of both the Test Booklet and the Answer Sheet.
13. **Do not fold or make any stray mark on the Answer Sheet.**

Name of the Candidate (in Capital letters) : \_\_\_\_\_

Roll Number : in figures 

--	--	--	--	--	--	--	--	--	--

: in words \_\_\_\_\_

Examination Centre Number : 

--	--	--	--	--	--	--

Name of Examination Centre (in Capital letters) : \_\_\_\_\_

Candidate's Signature : \_\_\_\_\_

1. Invigilator's Signature : \_\_\_\_\_

2. Invigilator's Signature : \_\_\_\_\_

**PART A – MATHEMATICS**

1. If the curves  $y^2 = 6x$ ,  $9x^2 + by^2 = 16$  intersect each other at right angles, then the value of b is :

- (1)  $\frac{9}{2}$
- (2) 6
- (3)  $\frac{7}{2}$
- (4) 4

2. Let  $\vec{u}$  be a vector coplanar with the vectors  $\vec{a} = 2\hat{i} + 3\hat{j} - \hat{k}$  and  $\vec{b} = \hat{j} + \hat{k}$ . If  $\vec{u}$

is perpendicular to  $\vec{a}$  and  $\vec{u} \cdot \vec{b} = 24$ ,

then  $|\vec{u}|^2$  is equal to :

- (1) 84
- (2) 336
- (3) 315
- (4) 256

3. For each  $t \in \mathbf{R}$ , let  $[t]$  be the greatest integer less than or equal to t. Then

$$\lim_{x \rightarrow 0^+} x \left( \left[ \frac{1}{x} \right] + \left[ \frac{2}{x} \right] + \dots + \left[ \frac{15}{x} \right] \right)$$

- (1) does not exist (in  $\mathbf{R}$ ).
- (2) is equal to 0.
- (3) is equal to 15.
- (4) is equal to 120.

4. If  $L_1$  is the line of intersection of the planes  $2x - 2y + 3z - 2 = 0$ ,  $x - y + z + 1 = 0$  and  $L_2$  is the line of intersection of the planes  $x + 2y - z - 3 = 0$ ,  $3x - y + 2z - 1 = 0$ , then the distance of the origin from the plane, containing the lines  $L_1$  and  $L_2$ , is :

- (1)  $\frac{1}{\sqrt{2}}$
- (2)  $\frac{1}{4\sqrt{2}}$
- (3)  $\frac{1}{3\sqrt{2}}$
- (4)  $\frac{1}{2\sqrt{2}}$

5. The value of  $\int_{-\frac{\pi}{2}}^{\frac{\pi}{2}} \frac{\sin^2 x}{1 + 2^x} dx$  is :

- (1)  $\frac{\pi}{4}$
- (2)  $\frac{\pi}{8}$
- (3)  $\frac{\pi}{2}$
- (4)  $4\pi$

6. Let  $g(x) = \cos x^2$ ,  $f(x) = \sqrt{x}$ , and  $\alpha, \beta$  ( $\alpha < \beta$ ) be the roots of the quadratic equation  $18x^2 - 9\pi x + \pi^2 = 0$ . Then the area (in sq. units) bounded by the curve  $y = (g \circ f)(x)$  and the lines  $x = \alpha$ ,  $x = \beta$  and  $y = 0$ , is :

- (1)  $\frac{1}{2}(\sqrt{2} - 1)$
- (2)  $\frac{1}{2}(\sqrt{3} - 1)$
- (3)  $\frac{1}{2}(\sqrt{3} + 1)$
- (4)  $\frac{1}{2}(\sqrt{3} - \sqrt{2})$

7. If sum of all the solutions of the equation  $8 \cos x \cdot \left( \cos\left(\frac{\pi}{6} + x\right) \cdot \cos\left(\frac{\pi}{6} - x\right) - \frac{1}{2} \right) = 1$  in  $[0, \pi]$  is  $k\pi$ , then  $k$  is equal to :

- (1)  $\frac{20}{9}$
- (2)  $\frac{2}{3}$
- (3)  $\frac{13}{9}$
- (4)  $\frac{8}{9}$

8. Let  $f(x) = x^2 + \frac{1}{x^2}$  and  $g(x) = x - \frac{1}{x}$ ,  $x \in \mathbf{R} - \{-1, 0, 1\}$ . If  $h(x) = \frac{f(x)}{g(x)}$ , then the local minimum value of  $h(x)$  is :

- (1)  $2\sqrt{2}$
- (2) 3
- (3) -3
- (4)  $-2\sqrt{2}$

9. The integral

$$\int \frac{\sin^2 x \cos^2 x}{(\sin^5 x + \cos^3 x \sin^2 x + \sin^3 x \cos^2 x + \cos^5 x)^2} dx$$

is equal to :

- (1)  $\frac{-1}{1 + \cot^3 x} + C$
- (2)  $\frac{1}{3(1 + \tan^3 x)} + C$
- (3)  $\frac{-1}{3(1 + \tan^3 x)} + C$
- (4)  $\frac{1}{1 + \cot^3 x} + C$

(where  $C$  is a constant of integration)

10. A bag contains 4 red and 6 black balls. A ball is drawn at random from the bag, its colour is observed and this ball along with two additional balls of the same colour are returned to the bag. If now a ball is drawn at random from the bag, then the probability that this drawn ball is red, is :

- (1)  $\frac{3}{4}$
- (2)  $\frac{3}{10}$
- (3)  $\frac{2}{5}$
- (4)  $\frac{1}{5}$

11. Let the orthocentre and centroid of a triangle be  $A(-3, 5)$  and  $B(3, 3)$  respectively. If  $C$  is the circumcentre of this triangle, then the radius of the circle having line segment  $AC$  as diameter, is :

- (1)  $\frac{3\sqrt{5}}{2}$
- (2)  $\sqrt{10}$
- (3)  $2\sqrt{10}$
- (4)  $3\sqrt{\frac{5}{2}}$

12. If the tangent at  $(1, 7)$  to the curve  $x^2 = y - 6$  touches the circle  $x^2 + y^2 + 16x + 12y + c = 0$  then the value of  $c$  is :

- (1) 95
- (2) 195
- (3) 185
- (4) 85

13. If  $\alpha, \beta \in \mathbb{C}$  are the distinct roots, of the equation  $x^2 - x + 1 = 0$ , then  $\alpha^{101} + \beta^{107}$  is equal to :
- (1) 2
  - (2) -1
  - (3) 0
  - (4) 1
14. PQR is a triangular park with  $PQ = PR = 200$  m. A T.V. tower stands at the mid-point of QR. If the angles of elevation of the top of the tower at P, Q and R are respectively  $45^\circ, 30^\circ$  and  $30^\circ$ , then the height of the tower (in m) is :
- (1)  $50\sqrt{2}$
  - (2) 100
  - (3) 50
  - (4)  $100\sqrt{3}$
15. If  $\sum_{i=1}^9 (x_i - 5) = 9$  and  $\sum_{i=1}^9 (x_i - 5)^2 = 45$ , then the standard deviation of the 9 items  $x_1, x_2, \dots, x_9$  is :
- (1) 3
  - (2) 9
  - (3) 4
  - (4) 2
16. The sum of the co-efficients of all odd degree terms in the expansion of  $(x + \sqrt{x^3 - 1})^5 + (x - \sqrt{x^3 - 1})^5, (x > 1)$  is :
- (1) 2
  - (2) -1
  - (3) 0
  - (4) 1
17. Tangents are drawn to the hyperbola  $4x^2 - y^2 = 36$  at the points P and Q. If these tangents intersect at the point T(0, 3) then the area (in sq. units) of  $\Delta PTQ$  is :
- (1)  $36\sqrt{5}$
  - (2)  $45\sqrt{5}$
  - (3)  $54\sqrt{3}$
  - (4)  $60\sqrt{3}$
18. From 6 different novels and 3 different dictionaries, 4 novels and 1 dictionary are to be selected and arranged in a row on a shelf so that the dictionary is always in the middle. The number of such arrangements is :
- (1) at least 750 but less than 1000
  - (2) at least 1000
  - (3) less than 500
  - (4) at least 500 but less than 750

19. If the system of linear equations

$$x + ky + 3z = 0$$

$$3x + ky - 2z = 0$$

$$2x + 4y - 3z = 0$$

has a non-zero solution  $(x, y, z)$ , then  $\frac{xz}{y^2}$

is equal to :

(1) 30

(2) -10

(3) 10

(4) -30

20. If  $\begin{vmatrix} x-4 & 2x & 2x \\ 2x & x-4 & 2x \\ 2x & 2x & x-4 \end{vmatrix} = (A + Bx)(x - A)^2$ ,

then the ordered pair  $(A, B)$  is equal to :

(1) (4, 5)

(2) (-4, -5)

(3) (-4, 3)

(4) (-4, 5)

21. Two sets A and B are as under :

$$A = \{(a, b) \in \mathbf{R} \times \mathbf{R} : |a - 5| < 1 \text{ and } |b - 5| < 1\};$$

$$B = \{(a, b) \in \mathbf{R} \times \mathbf{R} : 4(a - 6)^2 + 9(b - 5)^2 \leq 36\}. \text{ Then :}$$

(1) neither  $A \subset B$  nor  $B \subset A$

(2)  $B \subset A$

(3)  $A \subset B$

(4)  $A \cap B = \phi$  (an empty set)

22. Tangent and normal are drawn at  $P(16, 16)$  on the parabola  $y^2 = 16x$ , which intersect the axis of the parabola at A and B, respectively. If C is the centre of the circle through the points P, A and B and  $\angle CPB = \theta$ , then a value of  $\tan \theta$  is :

(1)  $\frac{4}{3}$

(2)  $\frac{1}{2}$

(3) 2

(4) 3

23. Let  $S = \{t \in \mathbf{R} : f(x) = |x - \pi| \cdot (e^{|x|} - 1) \sin|x|$  is not differentiable at  $t\}$ . Then the set S is equal to :

(1)  $\{0, \pi\}$

(2)  $\phi$  (an empty set)

(3)  $\{0\}$

(4)  $\{\pi\}$

24. The Boolean expression

$\sim(p \vee q) \vee (\sim p \wedge q)$  is equivalent to :

(1)  $\sim q$

(2)  $\sim p$

(3) p

(4) q

25. A straight line through a fixed point  $(2, 3)$  intersects the coordinate axes at distinct points P and Q. If O is the origin and the rectangle OPRQ is completed, then the locus of R is :

(1)  $3x + 2y = 6xy$

(2)  $3x + 2y = 6$

(3)  $2x + 3y = xy$

(4)  $3x + 2y = xy$

26. Let A be the sum of the first 20 terms and B be the sum of the first 40 terms of the series

$$1^2 + 2 \cdot 2^2 + 3^2 + 2 \cdot 4^2 + 5^2 + 2 \cdot 6^2 + \dots$$

If  $B - 2A = 100\lambda$ , then  $\lambda$  is equal to :

- (1) 496  
 (2) 232  
 (3) 248  
 (4) 464

27. Let  $y = y(x)$  be the solution of the differential equation

$$\sin x \frac{dy}{dx} + y \cos x = 4x, \quad x \in (0, \pi). \quad \text{If}$$

$y\left(\frac{\pi}{2}\right) = 0$ , then  $y\left(\frac{\pi}{6}\right)$  is equal to :

- (1)  $-\frac{4}{9} \pi^2$   
 (2)  $\frac{4}{9\sqrt{3}} \pi^2$   
 (3)  $\frac{-8}{9\sqrt{3}} \pi^2$   
 (4)  $-\frac{8}{9} \pi^2$

28. The length of the projection of the line segment joining the points  $(5, -1, 4)$  and  $(4, -1, 3)$  on the plane,  $x + y + z = 7$  is :

- (1)  $\sqrt{\frac{2}{3}}$   
 (2)  $\frac{2}{\sqrt{3}}$   
 (3)  $\frac{2}{3}$   
 (4)  $\frac{1}{3}$

29. Let  $S = \{x \in \mathbf{R} : x \geq 0 \text{ and } 2|\sqrt{x} - 3| + \sqrt{x}(\sqrt{x} - 6) + 6 = 0\}$ . Then S :

- (1) contains exactly four elements.  
 (2) is an empty set.  
 (3) contains exactly one element.  
 (4) contains exactly two elements.

30. Let  $a_1, a_2, a_3, \dots, a_{49}$  be in A.P. such that

$$\sum_{k=0}^{12} a_{4k+1} = 416 \quad \text{and} \quad a_9 + a_{43} = 66. \quad \text{If}$$

$a_1^2 + a_2^2 + \dots + a_{17}^2 = 140m$ , then  $m$  is equal to :

- (1) 33  
 (2) 66  
 (3) 68  
 (4) 34

**PART B – PHYSICS**

**ALL THE GRAPHS/DIAGRAMS GIVEN ARE SCHEMATIC AND NOT DRAWN TO SCALE.**

31. Three concentric metal shells A, B and C of respective radii  $a$ ,  $b$  and  $c$  ( $a < b < c$ ) have surface charge densities  $+\sigma$ ,  $-\sigma$  and  $+\sigma$  respectively. The potential of shell B is :

(1)  $\frac{\sigma}{\epsilon_0} \left[ \frac{b^2 - c^2}{c} + a \right]$

(2)  $\frac{\sigma}{\epsilon_0} \left[ \frac{a^2 - b^2}{a} + c \right]$

(3)  $\frac{\sigma}{\epsilon_0} \left[ \frac{a^2 - b^2}{b} + c \right]$

(4)  $\frac{\sigma}{\epsilon_0} \left[ \frac{b^2 - c^2}{b} + a \right]$

32. Seven identical circular planar disks, each of mass  $M$  and radius  $R$  are welded symmetrically as shown. The moment of inertia of the arrangement about the axis normal to the plane and passing through the point P is :

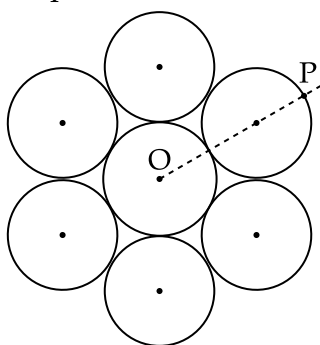

(1)  $\frac{181}{2} MR^2$

(2)  $\frac{19}{2} MR^2$

(3)  $\frac{55}{2} MR^2$

(4)  $\frac{73}{2} MR^2$

33. From a uniform circular disc of radius  $R$  and mass  $9M$ , a small disc of radius  $\frac{R}{3}$  is removed as shown in the figure. The moment of inertia of the remaining disc about an axis perpendicular to the plane of the disc and passing through centre of disc is :

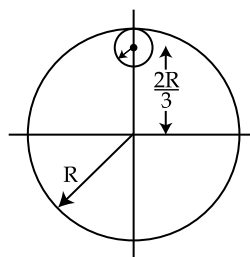

(1)  $\frac{37}{9} MR^2$

(2)  $4 MR^2$

(3)  $\frac{40}{9} MR^2$

(4)  $10 MR^2$

34. The reading of the ammeter for a silicon diode in the given circuit is :

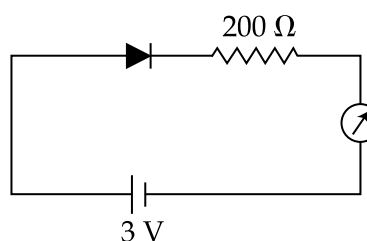

(1) 13.5 mA

(2) 0

(3) 15 mA

(4) 11.5 mA



35. Unpolarized light of intensity  $I$  passes through an ideal polarizer A. Another identical polarizer B is placed behind A. The intensity of light beyond B is found to be  $\frac{I}{2}$ . Now another identical polarizer C is placed between A and B. The intensity beyond B is now found to be  $\frac{I}{8}$ . The angle between polarizer A and C is :

- (1)  $60^\circ$
- (2)  $0^\circ$
- (3)  $30^\circ$
- (4)  $45^\circ$

36. For an RLC circuit driven with voltage of amplitude  $v_m$  and frequency  $\omega_0 = \frac{1}{\sqrt{LC}}$  the current exhibits resonance. The quality factor,  $Q$  is given by :

- (1)  $\frac{CR}{\omega_0}$
- (2)  $\frac{\omega_0 L}{R}$
- (3)  $\frac{\omega_0 R}{L}$
- (4)  $\frac{R}{(\omega_0 C)}$

37. Two masses  $m_1 = 5$  kg and  $m_2 = 10$  kg, connected by an inextensible string over a frictionless pulley, are moving as shown in the figure. The coefficient of friction of horizontal surface is 0.15. The minimum weight  $m$  that should be put on top of  $m_2$  to stop the motion is :

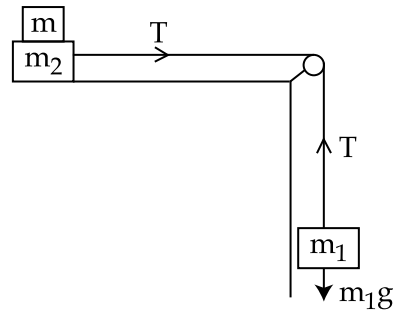

- (1) 10.3 kg
- (2) 18.3 kg
- (3) 27.3 kg
- (4) 43.3 kg

38. In a collinear collision, a particle with an initial speed  $v_0$  strikes a stationary particle of the same mass. If the final total kinetic energy is 50% greater than the original kinetic energy, the magnitude of the relative velocity between the two particles, after collision, is :

- (1)  $\frac{v_0}{\sqrt{2}}$
- (2)  $\frac{v_0}{4}$
- (3)  $\sqrt{2} v_0$
- (4)  $\frac{v_0}{2}$

39. A particle is moving with a uniform speed in a circular orbit of radius  $R$  in a central force inversely proportional to the  $n^{\text{th}}$  power of  $R$ . If the period of rotation of the particle is  $T$ , then :

- (1)  $T \propto R^{n/2}$
- (2)  $T \propto R^{3/2}$  for any  $n$ .
- (3)  $T \propto R^{\frac{n}{2}+1}$
- (4)  $T \propto R^{(n+1)/2}$

40. Two batteries with e.m.f. 12 V and 13 V are connected in parallel across a load resistor of  $10 \Omega$ . The internal resistances of the two batteries are  $1 \Omega$  and  $2 \Omega$  respectively. The voltage across the load lies between :

- (1) 11.7 V and 11.8 V
- (2) 11.6 V and 11.7 V
- (3) 11.5 V and 11.6 V
- (4) 11.4 V and 11.5 V

41. In an a.c. circuit, the instantaneous e.m.f. and current are given by

$$e = 100 \sin 30 t$$

$$i = 20 \sin \left( 30 t - \frac{\pi}{4} \right)$$

In one cycle of a.c., the average power consumed by the circuit and the wattless current are, respectively :

- (1) 50, 0
- (2) 50, 10
- (3)  $\frac{1000}{\sqrt{2}}$ , 10
- (4)  $\frac{50}{\sqrt{2}}$ , 0

42. An EM wave from air enters a medium. The electric fields are

$$\vec{E}_1 = E_{01} \hat{x} \cos \left[ 2 \pi \nu \left( \frac{z}{c} - t \right) \right] \text{ in air and}$$

$$\vec{E}_2 = E_{02} \hat{x} \cos [k (2 z - ct)] \text{ in medium,}$$

where the wave number  $k$  and frequency  $\nu$  refer to their values in air. The medium is non-magnetic. If  $\epsilon_{r1}$  and  $\epsilon_{r2}$  refer to relative permittivities of air and medium respectively, which of the following options is correct ?

$$(1) \frac{\epsilon_{r1}}{\epsilon_{r2}} = \frac{1}{2}$$

$$(2) \frac{\epsilon_{r1}}{\epsilon_{r2}} = 4$$

$$(3) \frac{\epsilon_{r1}}{\epsilon_{r2}} = 2$$

$$(4) \frac{\epsilon_{r1}}{\epsilon_{r2}} = \frac{1}{4}$$

43. A telephonic communication service is working at carrier frequency of 10 GHz. Only 10% of it is utilized for transmission. How many telephonic channels can be transmitted simultaneously if each channel requires a bandwidth of 5 kHz ?

- (1)  $2 \times 10^6$
- (2)  $2 \times 10^3$
- (3)  $2 \times 10^4$
- (4)  $2 \times 10^5$

44. A granite rod of 60 cm length is clamped at its middle point and is set into longitudinal vibrations. The density of granite is  $2.7 \times 10^3 \text{ kg/m}^3$  and its Young's modulus is  $9.27 \times 10^{10} \text{ Pa}$ . What will be the fundamental frequency of the longitudinal vibrations ?
- (1) 7.5 kHz
  - (2) 5 kHz
  - (3) 2.5 kHz
  - (4) 10 kHz
45. It is found that if a neutron suffers an elastic collinear collision with deuterium at rest, fractional loss of its energy is  $p_d$  ; while for its similar collision with carbon nucleus at rest, fractional loss of energy is  $p_c$ . The values of  $p_d$  and  $p_c$  are respectively :
- (1) (0, 1)
  - (2) (.89, .28)
  - (3) (.28, .89)
  - (4) (0, 0)
46. The density of a material in the shape of a cube is determined by measuring three sides of the cube and its mass. If the relative errors in measuring the mass and length are respectively 1.5% and 1%, the maximum error in determining the density is :
- (1) 6%
  - (2) 2.5%
  - (3) 3.5%
  - (4) 4.5%
47. Two moles of an ideal monoatomic gas occupies a volume  $V$  at  $27^\circ\text{C}$ . The gas expands adiabatically to a volume  $2V$ . Calculate (a) the final temperature of the gas and (b) change in its internal energy.
- (1) (a) 195 K (b) 2.7 kJ
  - (2) (a) 189 K (b) 2.7 kJ
  - (3) (a) 195 K (b) -2.7 kJ
  - (4) (a) 189 K (b) -2.7 kJ
48. A solid sphere of radius  $r$  made of a soft material of bulk modulus  $K$  is surrounded by a liquid in a cylindrical container. A massless piston of area  $a$  floats on the surface of the liquid, covering entire cross section of cylindrical container. When a mass  $m$  is placed on the surface of the piston to compress the liquid, the fractional decrement in the radius of the sphere,  $\left(\frac{dr}{r}\right)$ , is :
- (1)  $\frac{mg}{Ka}$
  - (2)  $\frac{Ka}{mg}$
  - (3)  $\frac{Ka}{3mg}$
  - (4)  $\frac{mg}{3Ka}$

49. A parallel plate capacitor of capacitance 90 pF is connected to a battery of emf 20 V. If a dielectric material of dielectric constant  $K = \frac{5}{3}$  is inserted between the plates, the magnitude of the induced charge will be :
- (1) 0.9 n C
  - (2) 1.2 n C
  - (3) 0.3 n C
  - (4) 2.4 n C
50. The dipole moment of a circular loop carrying a current  $I$ , is  $m$  and the magnetic field at the centre of the loop is  $B_1$ . When the dipole moment is doubled by keeping the current constant, the magnetic field at the centre of the loop is  $B_2$ . The ratio  $\frac{B_1}{B_2}$  is :
- (1)  $\frac{1}{\sqrt{2}}$
  - (2) 2
  - (3)  $\sqrt{3}$
  - (4)  $\sqrt{2}$
51. An electron from various excited states of hydrogen atom emit radiation to come to the ground state. Let  $\lambda_n, \lambda_g$  be the de Broglie wavelength of the electron in the  $n^{\text{th}}$  state and the ground state respectively. Let  $\Lambda_n$  be the wavelength of the emitted photon in the transition from the  $n^{\text{th}}$  state to the ground state. For large  $n$ , ( $A, B$  are constants)
- (1)  $\Lambda_n^2 \approx \lambda$
  - (2)  $\Lambda_n \approx A + \frac{B}{\lambda_n^2}$
  - (3)  $\Lambda_n \approx A + B \lambda_n$
  - (4)  $\Lambda_n^2 \approx A + B \lambda_n^2$
52. The mass of a hydrogen molecule is  $3.32 \times 10^{-27}$  kg. If  $10^{23}$  hydrogen molecules strike, per second, a fixed wall of area  $2 \text{ cm}^2$  at an angle of  $45^\circ$  to the normal, and rebound elastically with a speed of  $10^3 \text{ m/s}$ , then the pressure on the wall is nearly :
- (1)  $4.70 \times 10^2 \text{ N/m}^2$
  - (2)  $2.35 \times 10^3 \text{ N/m}^2$
  - (3)  $4.70 \times 10^3 \text{ N/m}^2$
  - (4)  $2.35 \times 10^2 \text{ N/m}^2$

53. All the graphs below are intended to represent the same motion. One of them does it incorrectly. Pick it up.

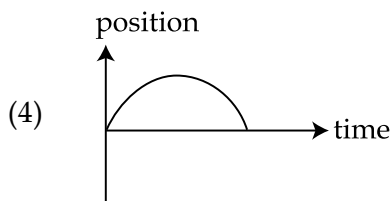
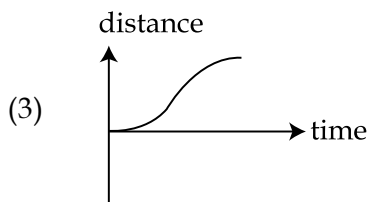
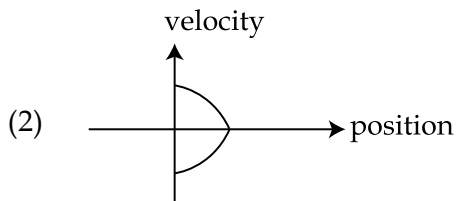
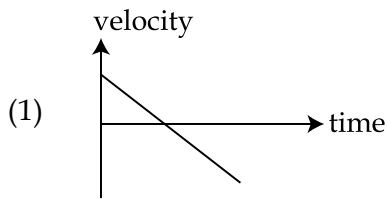

54. An electron, a proton and an alpha particle having the same kinetic energy are moving in circular orbits of radii  $r_e$ ,  $r_p$ ,  $r_\alpha$  respectively in a uniform magnetic field  $B$ . The relation between  $r_e$ ,  $r_p$ ,  $r_\alpha$  is :

- (1)  $r_e < r_\alpha < r_p$
- (2)  $r_e > r_p = r_\alpha$
- (3)  $r_e < r_p = r_\alpha$
- (4)  $r_e < r_p < r_\alpha$

55. On interchanging the resistances, the balance point of a meter bridge shifts to the left by 10 cm. The resistance of their series combination is  $1\text{ k}\Omega$ . How much was the resistance on the left slot before interchanging the resistances ?

- (1)  $910\ \Omega$
- (2)  $990\ \Omega$
- (3)  $505\ \Omega$
- (4)  $550\ \Omega$

56. In a potentiometer experiment, it is found that no current passes through the galvanometer when the terminals of the cell are connected across 52 cm of the potentiometer wire. If the cell is shunted by a resistance of  $5\ \Omega$ , a balance is found when the cell is connected across 40 cm of the wire. Find the internal resistance of the cell.

- (1)  $2.5\ \Omega$
- (2)  $1\ \Omega$
- (3)  $1.5\ \Omega$
- (4)  $2\ \Omega$

57. If the series limit frequency of the Lyman series is  $\nu_L$ , then the series limit frequency of the Pfund series is :

- (1)  $\nu_L/25$
- (2)  $25 \nu_L$
- (3)  $16 \nu_L$
- (4)  $\nu_L/16$

58. The angular width of the central maximum in a single slit diffraction pattern is  $60^\circ$ . The width of the slit is  $1 \mu\text{m}$ . The slit is illuminated by monochromatic plane waves. If another slit of same width is made near it, Young's fringes can be observed on a screen placed at a distance 50 cm from the slits. If the observed fringe width is 1 cm, what is slit separation distance ?

(i.e. distance between the centres of each slit.)

- (1)  $100 \mu\text{m}$
- (2)  $25 \mu\text{m}$
- (3)  $50 \mu\text{m}$
- (4)  $75 \mu\text{m}$

59. A particle is moving in a circular path of radius  $a$  under the action of an attractive potential  $U = -\frac{k}{2r^2}$ . Its total energy is :

- (1)  $-\frac{3}{2} \frac{k}{a^2}$
- (2)  $-\frac{k}{4a^2}$
- (3)  $\frac{k}{2a^2}$
- (4) Zero

60. A silver atom in a solid oscillates in simple harmonic motion in some direction with a frequency of  $10^{12}/\text{sec}$ . What is the force constant of the bonds connecting one atom with the other ? (Mole wt. of silver = 108 and Avagadro number =  $6.02 \times 10^{23} \text{ gm mole}^{-1}$ )

- (1) 5.5 N/m
- (2) 6.4 N/m
- (3) 7.1 N/m
- (4) 2.2 N/m

PART C – CHEMISTRY

61. For 1 molal aqueous solution of the following compounds, which one will show the highest freezing point ?

- (1)  $[\text{Co}(\text{H}_2\text{O})_3\text{Cl}_3] \cdot 3\text{H}_2\text{O}$
- (2)  $[\text{Co}(\text{H}_2\text{O})_6]\text{Cl}_3$
- (3)  $[\text{Co}(\text{H}_2\text{O})_5\text{Cl}]\text{Cl}_2 \cdot \text{H}_2\text{O}$
- (4)  $[\text{Co}(\text{H}_2\text{O})_4\text{Cl}_2]\text{Cl} \cdot 2\text{H}_2\text{O}$

62. Hydrogen peroxide oxidises  $[\text{Fe}(\text{CN})_6]^{4-}$  to  $[\text{Fe}(\text{CN})_6]^{3-}$  in acidic medium but reduces  $[\text{Fe}(\text{CN})_6]^{3-}$  to  $[\text{Fe}(\text{CN})_6]^{4-}$  in alkaline medium. The other products formed are, respectively :

- (1)  $\text{H}_2\text{O}$  and  $(\text{H}_2\text{O} + \text{OH}^-)$
- (2)  $(\text{H}_2\text{O} + \text{O}_2)$  and  $\text{H}_2\text{O}$
- (3)  $(\text{H}_2\text{O} + \text{O}_2)$  and  $(\text{H}_2\text{O} + \text{OH}^-)$
- (4)  $\text{H}_2\text{O}$  and  $(\text{H}_2\text{O} + \text{O}_2)$

63. Which of the following compounds will be suitable for Kjeldahl's method for nitrogen estimation ?

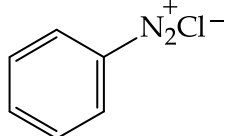
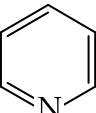
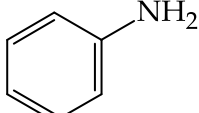
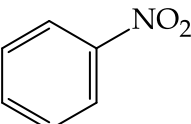
- (1) 
- (2) 
- (3) 
- (4) 

64. Glucose on prolonged heating with HI gives :

- (1) 6-iodohexanal
- (2) *n*-Hexane
- (3) 1-Hexene
- (4) Hexanoic acid

65. An alkali is titrated against an acid with methyl orange as indicator, which of the following is a correct combination ?

	Base	Acid	End point
(1)	Strong	Strong	Pink to colourless
(2)	Weak	Strong	Colourless to pink
(3)	Strong	Strong	Pinkish red to yellow
(4)	Weak	Strong	Yellow to pinkish red

66. The predominant form of histamine present in human blood is ( $\text{pK}_a$ , Histidine = 6.0)

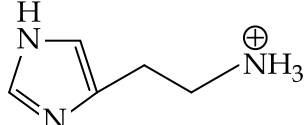
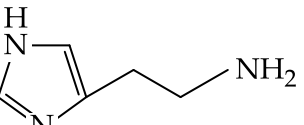
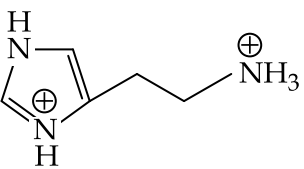
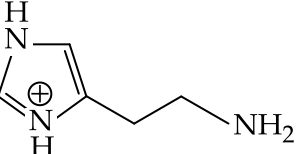
- (1) 
- (2) 
- (3) 
- (4) 

67. The increasing order of basicity of the following compounds is :

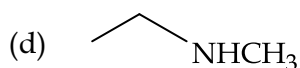
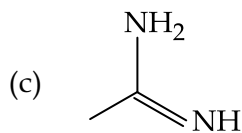
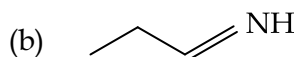
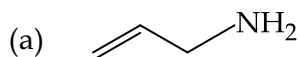

- (1) (d) < (b) < (a) < (c)
- (2) (a) < (b) < (c) < (d)
- (3) (b) < (a) < (c) < (d)
- (4) (b) < (a) < (d) < (c)

68. Which of the following lines correctly show the temperature dependence of equilibrium constant, K, for an exothermic reaction ?

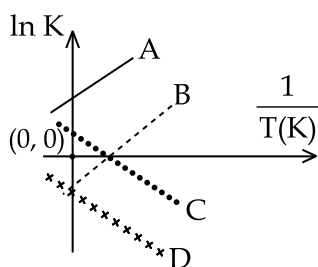

- (1) A and D
- (2) A and B
- (3) B and C
- (4) C and D

69. How long (approximate) should water be electrolysed by passing through 100 amperes current so that the oxygen released can completely burn 27.66 g of diborane ?

(Atomic weight of B = 10.8 u)

- (1) 1.6 hours
- (2) 6.4 hours
- (3) 0.8 hours
- (4) 3.2 hours

70. Consider the following reaction and statements :

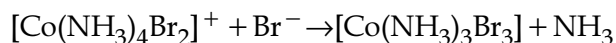

- (I) Two isomers are produced if the reactant complex ion is a *cis*-isomer.
- (II) Two isomers are produced if the reactant complex ion is a *trans*-isomer.
- (III) Only one isomer is produced if the reactant complex ion is a *trans*-isomer.
- (IV) Only one isomer is produced if the reactant complex ion is a *cis*-isomer.

The correct statements are :

- (1) (II) and (IV)
- (2) (I) and (II)
- (3) (I) and (III)
- (4) (III) and (IV)



71. Phenol reacts with methyl chloroformate in the presence of NaOH to form product A. A reacts with Br<sub>2</sub> to form product B. A and B are respectively :

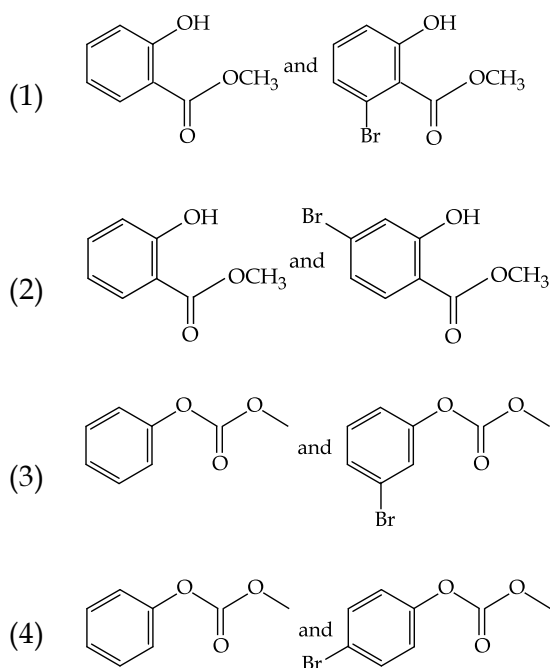

72. An aqueous solution contains an unknown concentration of Ba<sup>2+</sup>. When 50 mL of a 1 M solution of Na<sub>2</sub>SO<sub>4</sub> is added, BaSO<sub>4</sub> just begins to precipitate. The final volume is 500 mL. The solubility product of BaSO<sub>4</sub> is 1 × 10<sup>-10</sup>. What is the original concentration of Ba<sup>2+</sup> ?

- (1) 1.0 × 10<sup>-10</sup> M  
 (2) 5 × 10<sup>-9</sup> M  
 (3) 2 × 10<sup>-9</sup> M  
 (4) 1.1 × 10<sup>-9</sup> M

73. At 518° C, the rate of decomposition of a sample of gaseous acetaldehyde, initially at a pressure of 363 Torr, was 1.00 Torr s<sup>-1</sup> when 5% had reacted and 0.5 Torr s<sup>-1</sup> when 33% had reacted. The order of the reaction is :

- (1) 0  
 (2) 2  
 (3) 3  
 (4) 1

74. The combustion of benzene (l) gives CO<sub>2</sub>(g) and H<sub>2</sub>O(l). Given that heat of combustion of benzene at constant volume is -3263.9 kJ mol<sup>-1</sup> at 25° C; heat of combustion (in kJ mol<sup>-1</sup>) of benzene at constant pressure will be :

(R = 8.314 JK<sup>-1</sup> mol<sup>-1</sup>)

- (1) -3267.6  
 (2) 4152.6  
 (3) -452.46  
 (4) 3260

75. The ratio of mass percent of C and H of an organic compound (C<sub>x</sub>H<sub>y</sub>O<sub>z</sub>) is 6 : 1. If one molecule of the above compound (C<sub>x</sub>H<sub>y</sub>O<sub>z</sub>) contains half as much oxygen as required to burn one molecule of compound C<sub>x</sub>H<sub>y</sub> completely to CO<sub>2</sub> and H<sub>2</sub>O. The empirical formula of compound C<sub>x</sub>H<sub>y</sub>O<sub>z</sub> is :

- (1) C<sub>2</sub>H<sub>4</sub>O<sub>3</sub>  
 (2) C<sub>3</sub>H<sub>6</sub>O<sub>3</sub>  
 (3) C<sub>2</sub>H<sub>4</sub>O  
 (4) C<sub>3</sub>H<sub>4</sub>O<sub>2</sub>

76. The *trans*-alkenes are formed by the reduction of alkynes with :

- (1) Sn - HCl
- (2) H<sub>2</sub> - Pd/C, BaSO<sub>4</sub>
- (3) NaBH<sub>4</sub>
- (4) Na/liq. NH<sub>3</sub>

77. Which of the following are Lewis acids ?

- (1) BCl<sub>3</sub> and AlCl<sub>3</sub>
- (2) PH<sub>3</sub> and BCl<sub>3</sub>
- (3) AlCl<sub>3</sub> and SiCl<sub>4</sub>
- (4) PH<sub>3</sub> and SiCl<sub>4</sub>

78. When metal 'M' is treated with NaOH, a white gelatinous precipitate 'X' is obtained, which is soluble in excess of NaOH. Compound 'X' when heated strongly gives an oxide which is used in chromatography as an adsorbent. The metal 'M' is :

- (1) Fe
- (2) Zn
- (3) Ca
- (4) Al

79. According to molecular orbital theory, which of the following will **not** be a viable molecule ?

- (1) H<sub>2</sub><sup>2-</sup>
- (2) He<sub>2</sub><sup>2+</sup>
- (3) He<sub>2</sub><sup>+</sup>
- (4) H<sub>2</sub><sup>-</sup>

80. The major product formed in the following reaction is :

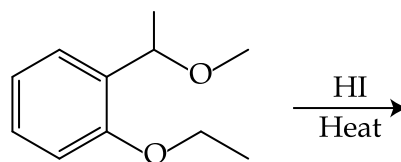

- (1)
- (2)
- (3)
- (4)

81. Phenol on treatment with  $\text{CO}_2$  in the presence of  $\text{NaOH}$  followed by acidification produces compound X as the major product. X on treatment with  $(\text{CH}_3\text{CO})_2\text{O}$  in the presence of catalytic amount of  $\text{H}_2\text{SO}_4$  produces :

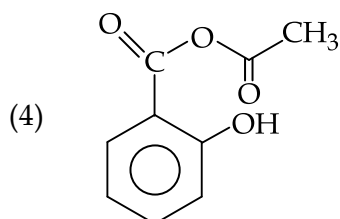
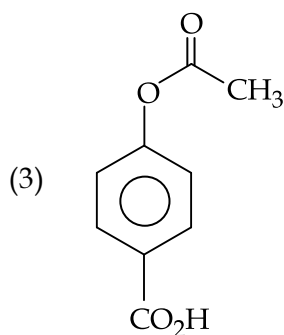
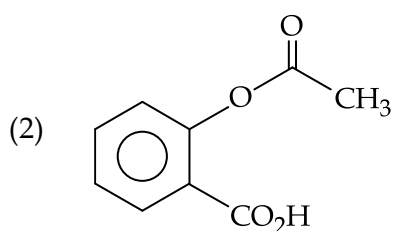
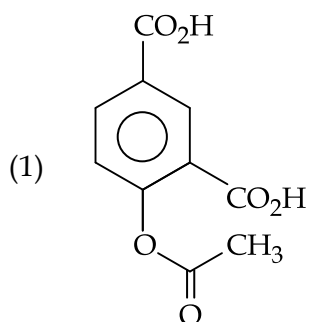

82. Which of the following compounds contain(s) no covalent bond(s) ?

$\text{KCl}$ ,  $\text{PH}_3$ ,  $\text{O}_2$ ,  $\text{B}_2\text{H}_6$ ,  $\text{H}_2\text{SO}_4$

- (1)  $\text{KCl}$ ,  $\text{B}_2\text{H}_6$
- (2)  $\text{KCl}$ ,  $\text{B}_2\text{H}_6$ ,  $\text{PH}_3$
- (3)  $\text{KCl}$ ,  $\text{H}_2\text{SO}_4$
- (4)  $\text{KCl}$

83. Which type of 'defect' has the presence of cations in the interstitial sites ?

- (1) Metal deficiency defect
- (2) Schottky defect
- (3) Vacancy defect
- (4) Frenkel defect

84. The major product of the following reaction is :

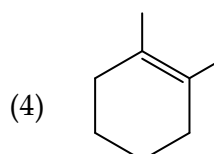
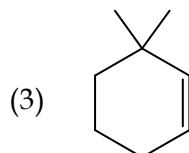
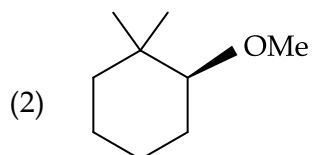
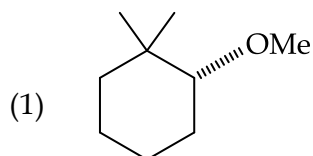
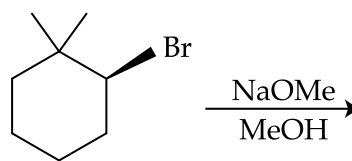

85. The compound that **does not** produce nitrogen gas by the thermal decomposition is :
- (1)  $(\text{NH}_4)_2\text{SO}_4$
  - (2)  $\text{Ba}(\text{N}_3)_2$
  - (3)  $(\text{NH}_4)_2\text{Cr}_2\text{O}_7$
  - (4)  $\text{NH}_4\text{NO}_2$
86. An aqueous solution contains 0.10 M  $\text{H}_2\text{S}$  and 0.20 M  $\text{HCl}$ . If the equilibrium constants for the formation of  $\text{HS}^-$  from  $\text{H}_2\text{S}$  is  $1.0 \times 10^{-7}$  and that of  $\text{S}^{2-}$  from  $\text{HS}^-$  ions is  $1.2 \times 10^{-13}$  then the concentration of  $\text{S}^{2-}$  ions in aqueous solution is :
- (1)  $5 \times 10^{-19}$
  - (2)  $5 \times 10^{-8}$
  - (3)  $3 \times 10^{-20}$
  - (4)  $6 \times 10^{-21}$
87. The oxidation states of Cr in  $[\text{Cr}(\text{H}_2\text{O})_6]\text{Cl}_3$ ,  $[\text{Cr}(\text{C}_6\text{H}_6)_2]$ , and  $\text{K}_2[\text{Cr}(\text{CN})_2(\text{O})_2(\text{O}_2)(\text{NH}_3)]$  respectively are :
- (1) +3, 0, and +4
  - (2) +3, +4, and +6
  - (3) +3, +2, and +4
  - (4) +3, 0, and +6
88. The recommended concentration of fluoride ion in drinking water is up to 1 ppm as fluoride ion is required to make teeth enamel harder by converting  $[\text{3Ca}_3(\text{PO}_4)_2 \cdot \text{Ca}(\text{OH})_2]$  to :
- (1)  $[\text{3}\{\text{Ca}(\text{OH})_2\} \cdot \text{CaF}_2]$
  - (2)  $[\text{CaF}_2]$
  - (3)  $[\text{3}(\text{CaF}_2) \cdot \text{Ca}(\text{OH})_2]$
  - (4)  $[\text{3Ca}_3(\text{PO}_4)_2 \cdot \text{CaF}_2]$
89. Which of the following salts is the most basic in aqueous solution ?
- (1)  $\text{Pb}(\text{CH}_3\text{COO})_2$
  - (2)  $\text{Al}(\text{CN})_3$
  - (3)  $\text{CH}_3\text{COOK}$
  - (4)  $\text{FeCl}_3$
90. Total number of lone pair of electrons in  $\text{I}_3^-$  ion is :
- (1) 12
  - (2) 3
  - (3) 6
  - (4) 9

- o o o -

SPACE FOR ROUGH WORK

**SPACE FOR ROUGH WORK**

**SPACE FOR ROUGH WORK**

**SPACE FOR ROUGH WORK**

**SPACE FOR ROUGH WORK**



***Read the following instructions carefully :***

1. The candidates should fill in the required particulars on the Test Booklet and Answer Sheet (*Side-1*) with ***Black Ball Point Pen***.
2. For writing/marking particulars on *Side-2* of the Answer Sheet, use ***Black Ball Point Pen only***.
3. The candidates should not write their Roll Numbers anywhere else (except in the specified space) on the Test Booklet/Answer Sheet.
4. Out of the four options given for each question, only one option is the correct answer.
5. For each ***incorrect response***,  $\frac{1}{4}$  (***one-fourth***) marks of the total marks allotted to the question (i.e. 1 mark) will be deducted from the total score. ***No deduction*** from the total score, however, will be made ***if no response*** is indicated for an item in the Answer Sheet.
6. Handle the Test Booklet and Answer Sheet with care, ***as under no circumstances (except for discrepancy in Test Booklet Code and Answer Sheet Code), another set will be provided.***
7. The candidates are not allowed to do any rough work or writing work on the Answer Sheet. All calculations/writing work are to be done in the space provided for this purpose in the Test Booklet itself, marked 'Space for Rough Work'. This space is given at the bottom of each page and in four pages (Page 20-23) at the end of the booklet.
8. On completion of the test, the candidates must hand over the Answer Sheet to the Invigilator on duty in the Room/Hall. **However, the candidates are allowed to take away this Test Booklet with them.**
9. Each candidate must show on demand his/her Admit Card to the Invigilator.
10. No candidate, without special permission of the Superintendent or Invigilator, should leave his/her seat.
11. The candidates should not leave the Examination Hall without handing over their Answer Sheet to the Invigilator on duty and sign the Attendance Sheet again. Cases where a candidate has not signed the Attendance Sheet second time will be deemed not to have handed over the Answer Sheet and dealt with as an unfair means case. **The candidates are also required to put their left hand THUMB impression in the space provided in the Attendance Sheet.**
12. Use of Electronic/Manual Calculator and any Electronic device like mobile phone, pager etc. is prohibited.
13. The candidates are governed by all Rules and Regulations of the Examination body with regard to their conduct in the Examination Hall. All cases of unfair means will be dealt with as per Rules and Regulations of the Examination body.
14. No part of the Test Booklet and Answer Sheet shall be detached under any circumstances.
15. **Candidates are not allowed to carry any textual material, printed or written, bits of papers, pager, mobile phone, electronic device or any other material except the Admit Card inside the examination room/hall.**

QNO	ANS	QNO	ANS	QNO	ANS	QNO	ANS
1	1	26	3	51	2	76	4
2	2	27	4	52	2	77	1
3	4	28	1	53	3	78	4
4	3	29	4	54	3	79	1
5	1	30	4	55	4	80	1
6	2	31	3	56	3	81	2
7	3	32	1	57	1	82	4
8	1	33	2	58	2	83	4
9	3	34	4	59	4	84	3
10	3	35	4	60	3	85	1
11	4	36	2	61	1	86	3
12	1	37	3	62	4	87	4
13	4	38	3	63	3	88	4
14	2	39	4	64	2	89	3
15	4	40	3	65	4	90	4
16	1	41	3	66	1		
17	2	42	4	67	4		
18	2	43	4	68	2		
19	3	44	2	69	4		
20	4	45	2	70	3		
21	3	46	4	71	4		
22	3	47	4	72	4		
23	2	48	4	73	2		
24	2	49	2	74	1		
25	4	50	4	75	1		